

FIG. 1

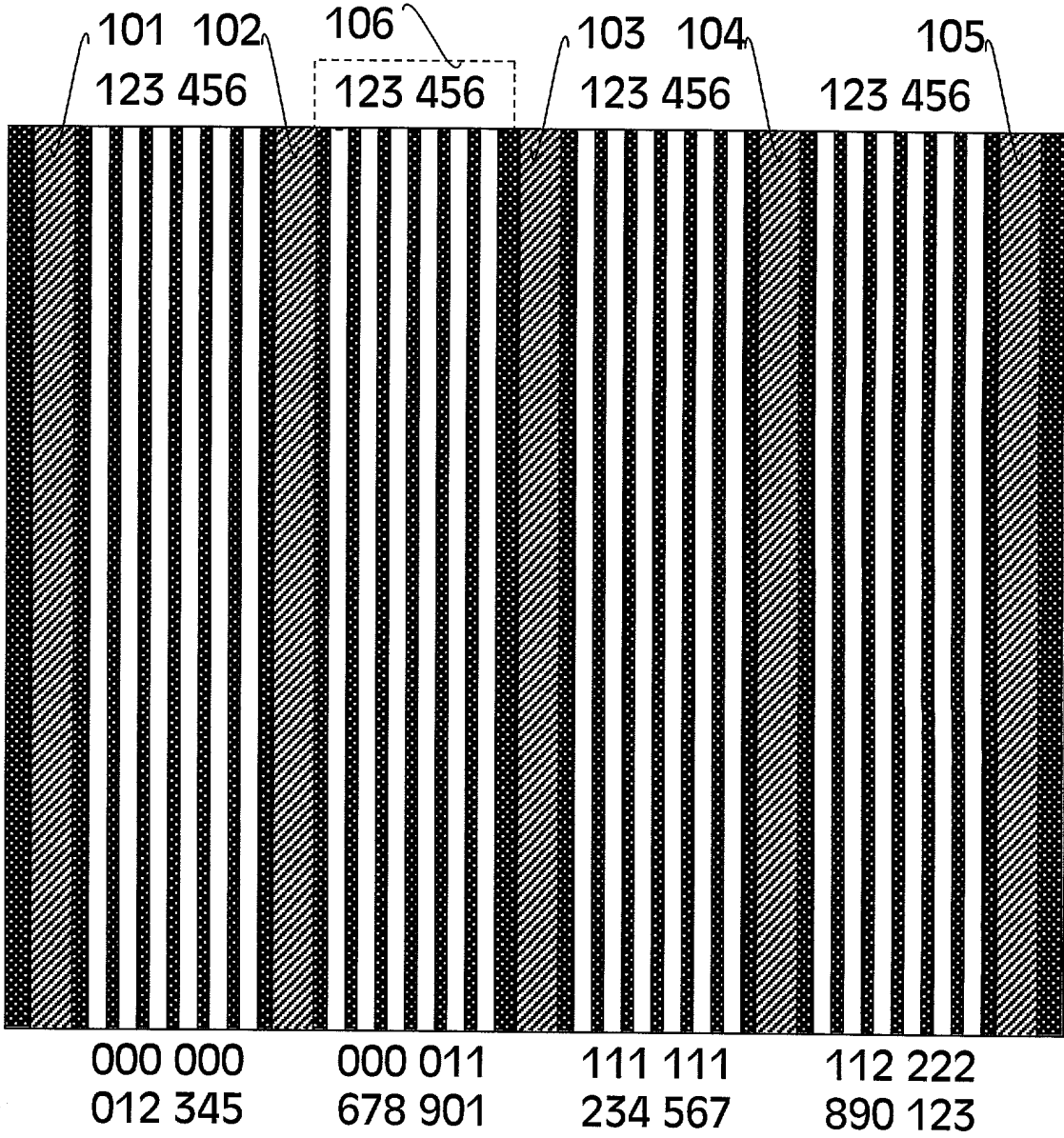

FIG. 1

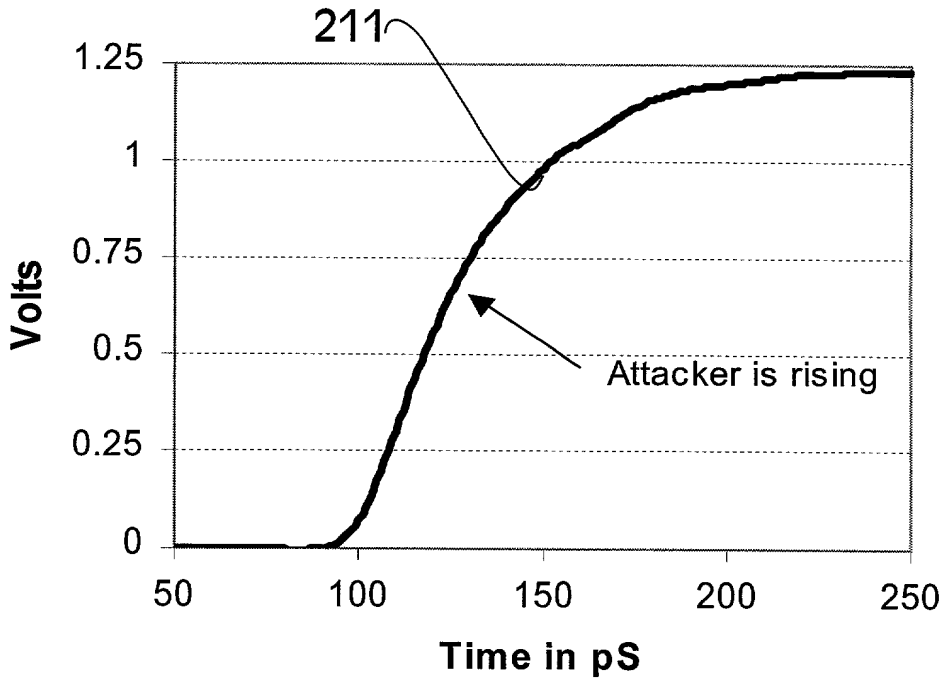

FIG. 2a

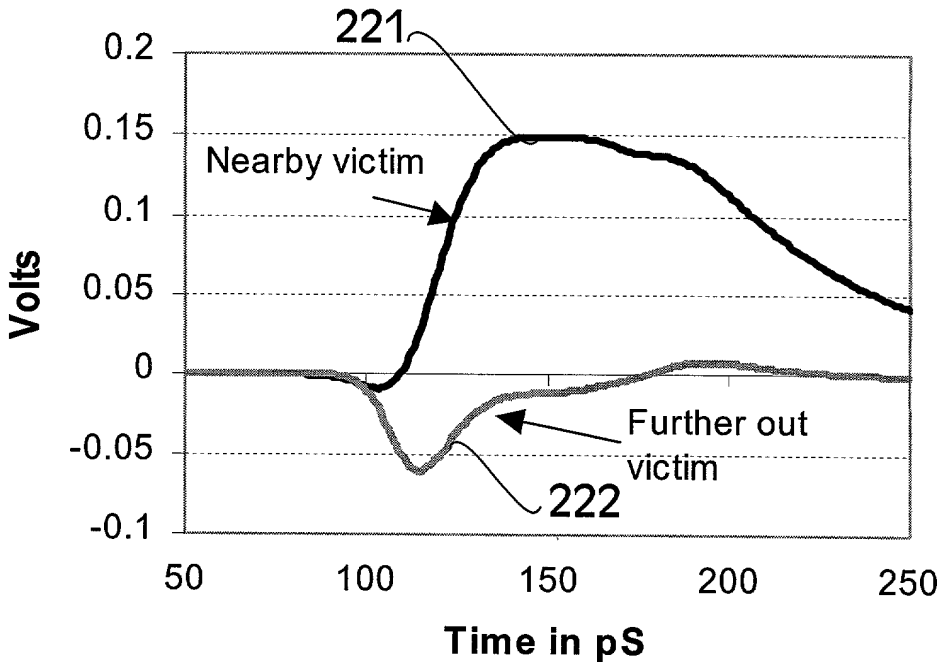

FIG. 2b

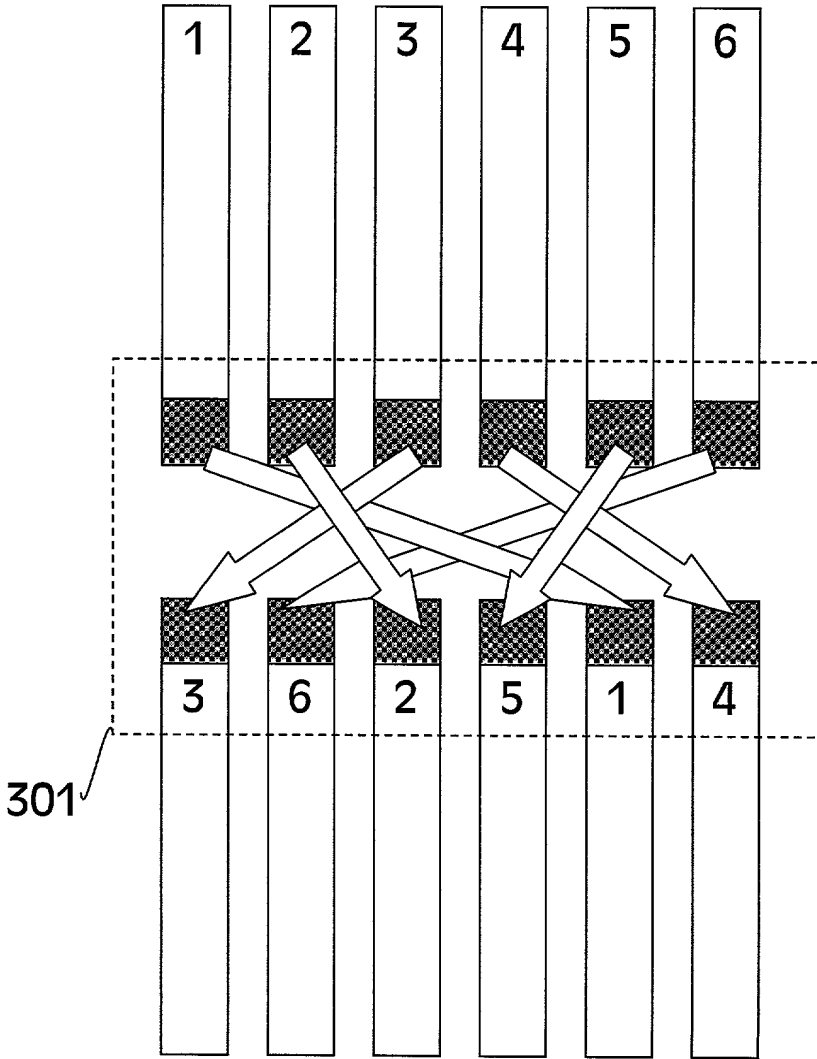

FIG. 3

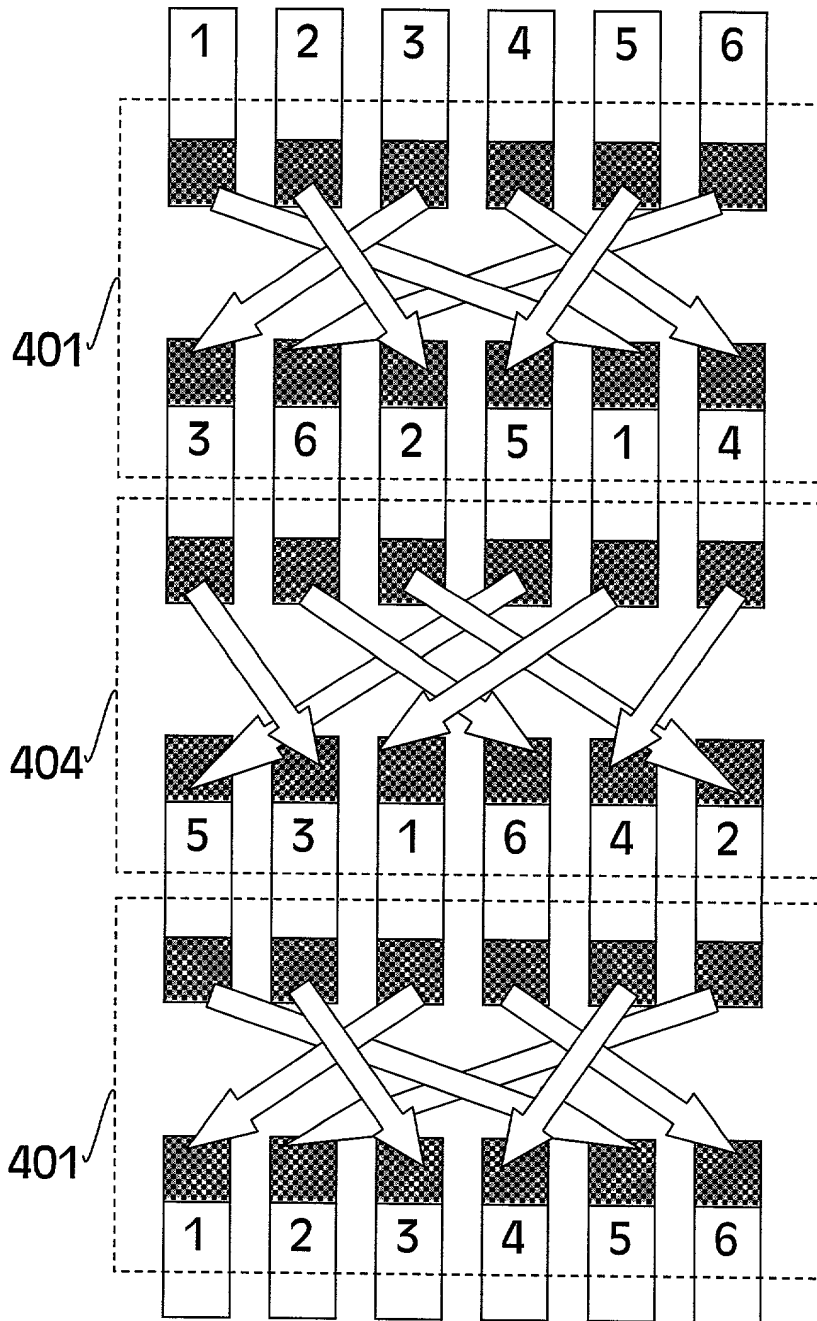

FIG. 4a

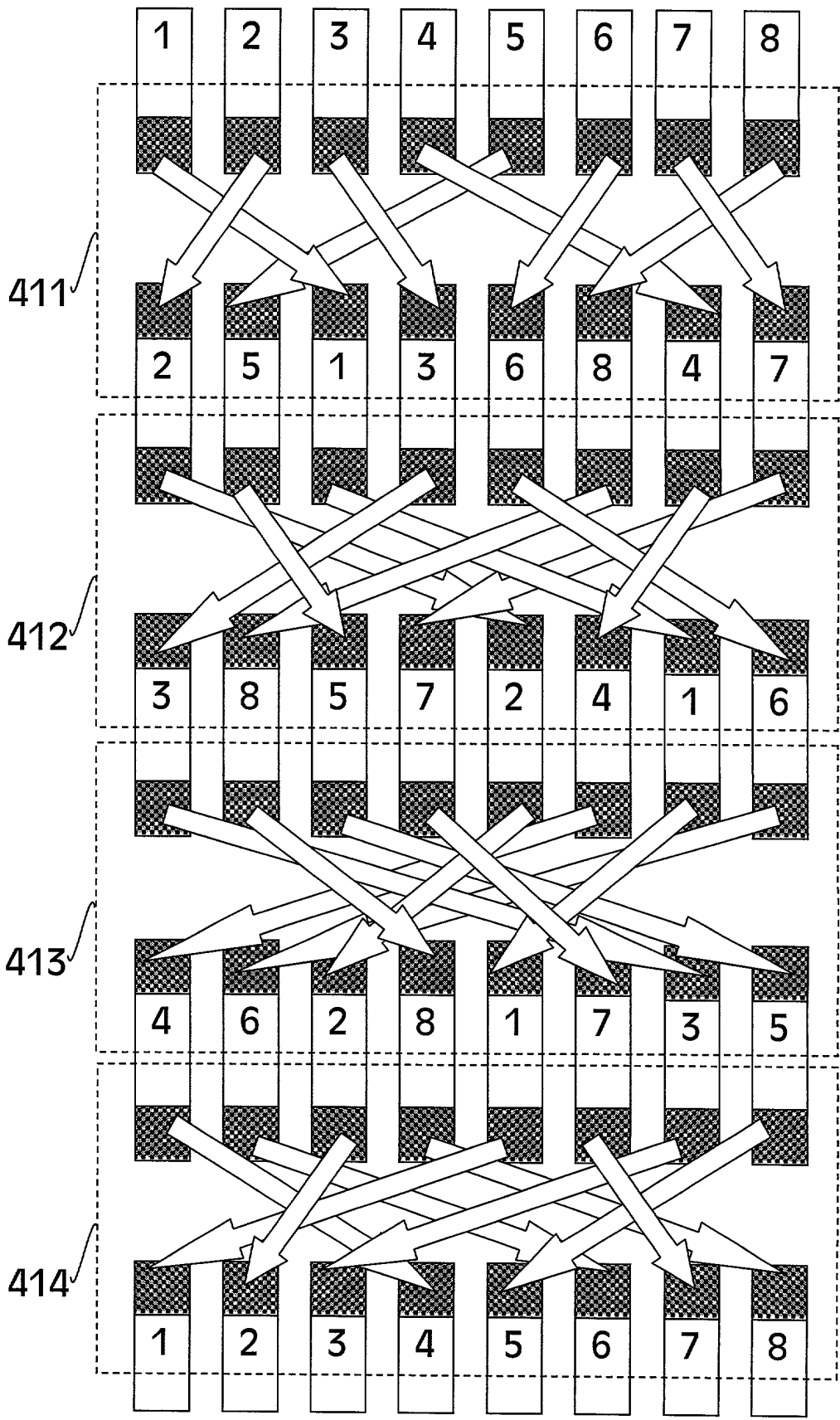
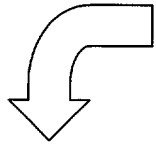

FIG. 4b

FIG. 5

| | | | | | | |
|---|---|---|---|---|---|---|
| | 1 | 2 | 3 | 4 | 5 | 6 |
| 1 | 1 | 1 | 0 | 0 | 0 | 0 |
| 2 | 1 | 1 | 1 | 0 | 0 | 0 |
| 3 | 0 | 1 | 1 | 1 | 0 | 0 |
| 4 | 0 | 0 | 1 | 1 | 1 | 0 |
| 5 | 0 | 0 | 0 | 1 | 1 | 1 |
| 6 | 0 | 0 | 0 | 0 | 1 | 1 |

506



| | | | | | |
|---|---|---|---|---|---|
| 3 | 1 | 5 | 2 | 6 | 4 |
|---|---|---|---|---|---|

501

| | | | | | | |
|---|---|---|---|---|---|---|
| | 1 | 2 | 3 | 4 | 5 | 6 |
| 1 | 1 | 1 | 1 | 0 | 1 | 0 |
| 2 | 1 | 1 | 1 | 0 | 1 | 1 |
| 3 | 1 | 1 | 1 | 1 | 0 | 0 |
| 4 | 0 | 0 | 1 | 1 | 1 | 1 |
| 5 | 1 | 1 | 0 | 1 | 1 | 1 |
| 6 | 0 | 1 | 0 | 1 | 1 | 1 |

507

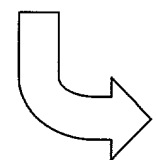

| | | | | | |
|---|---|---|---|---|---|
| 2 | 4 | 1 | 6 | 3 | 5 |
|---|---|---|---|---|---|

504

| | | | | | | |
|---|---|---|---|---|---|---|
| | 1 | 2 | 3 | 4 | 5 | 6 |
| 1 | 1 | 1 | 1 | 1 | 1 | 1 |
| 2 | 1 | 1 | 1 | 1 | 1 | 1 |
| 3 | 1 | 1 | 1 | 1 | 1 | 1 |
| 4 | 1 | 1 | 1 | 1 | 1 | 1 |
| 5 | 1 | 1 | 1 | 1 | 1 | 1 |
| 6 | 1 | 1 | 1 | 1 | 1 | 1 |

508

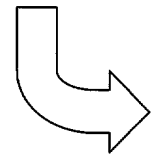
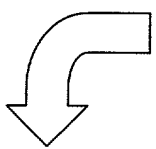

FIG. 5

FIG. 6a

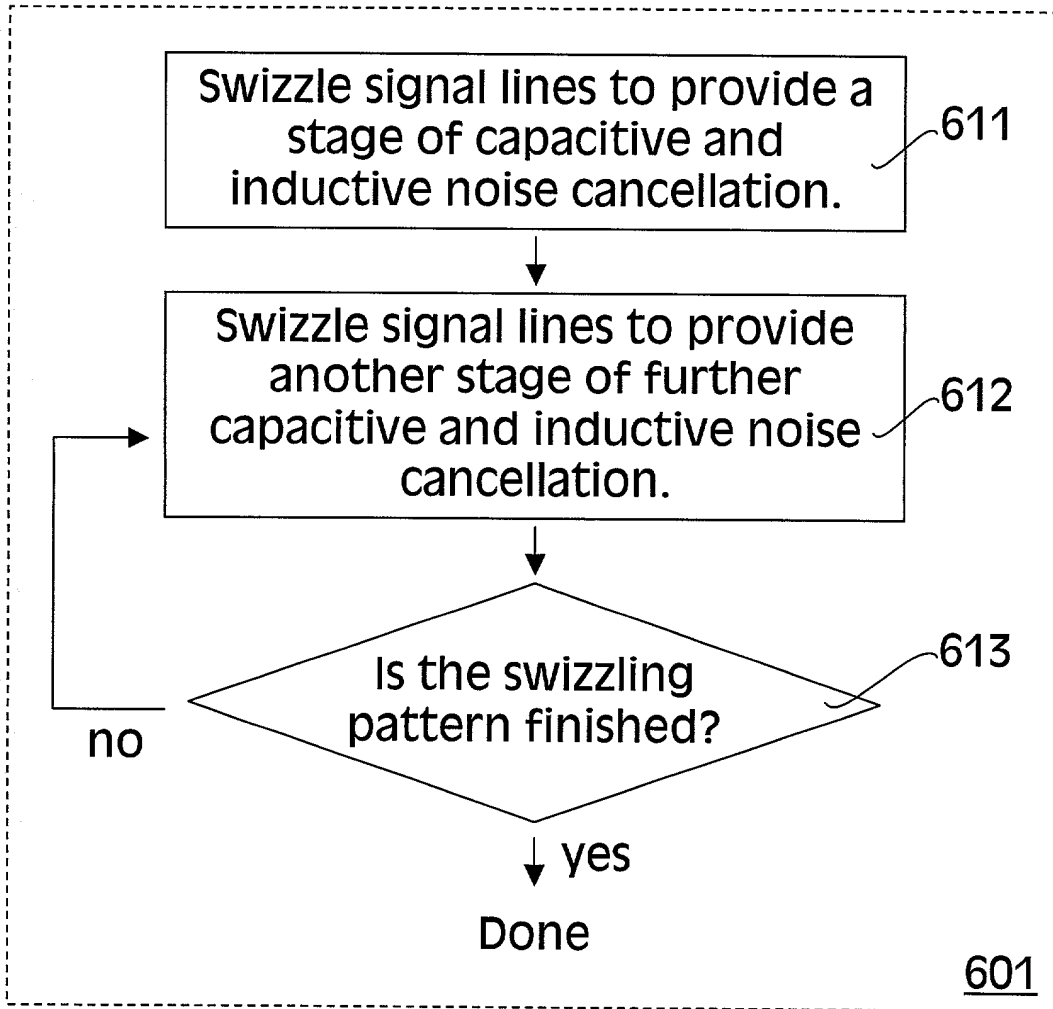
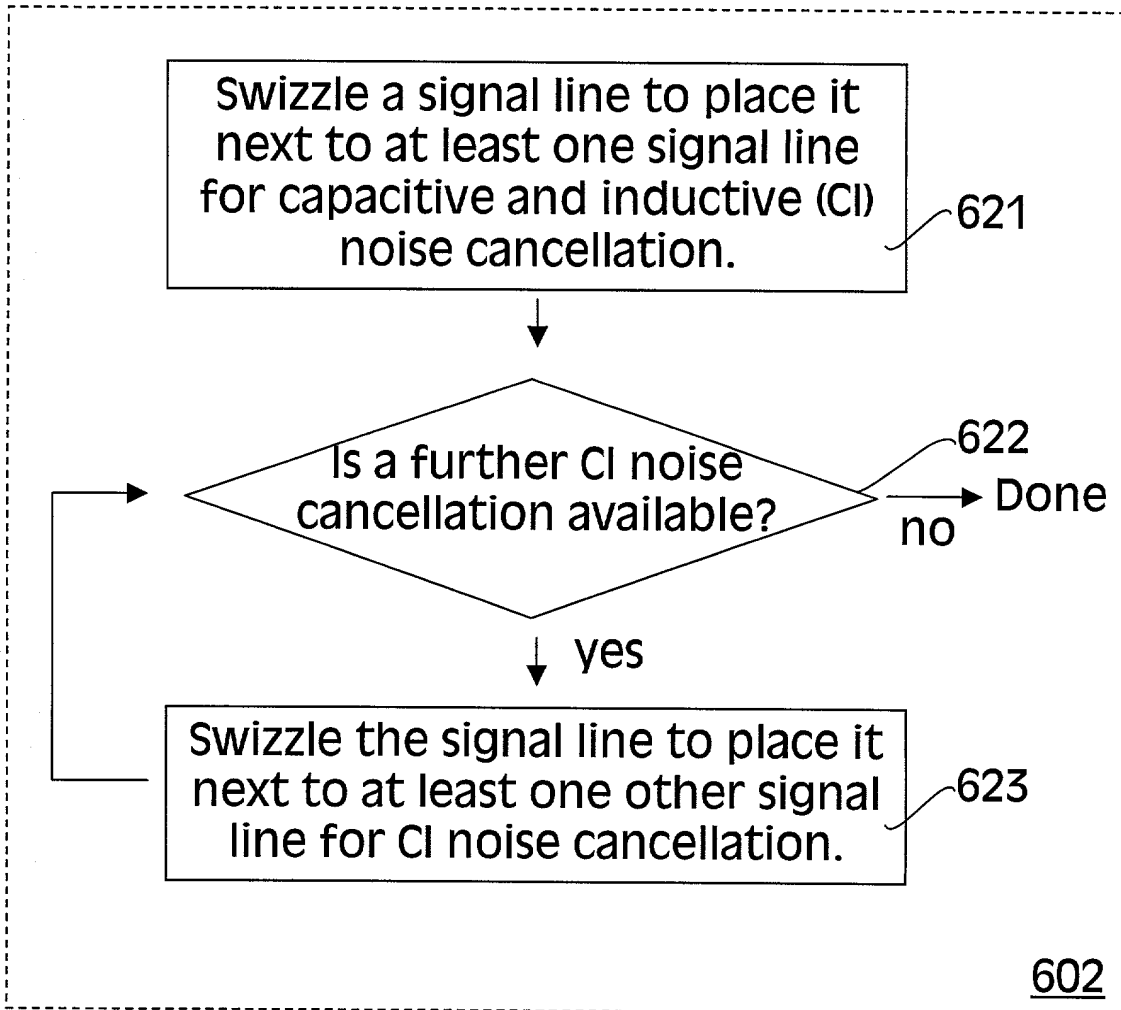

FIG. 6b



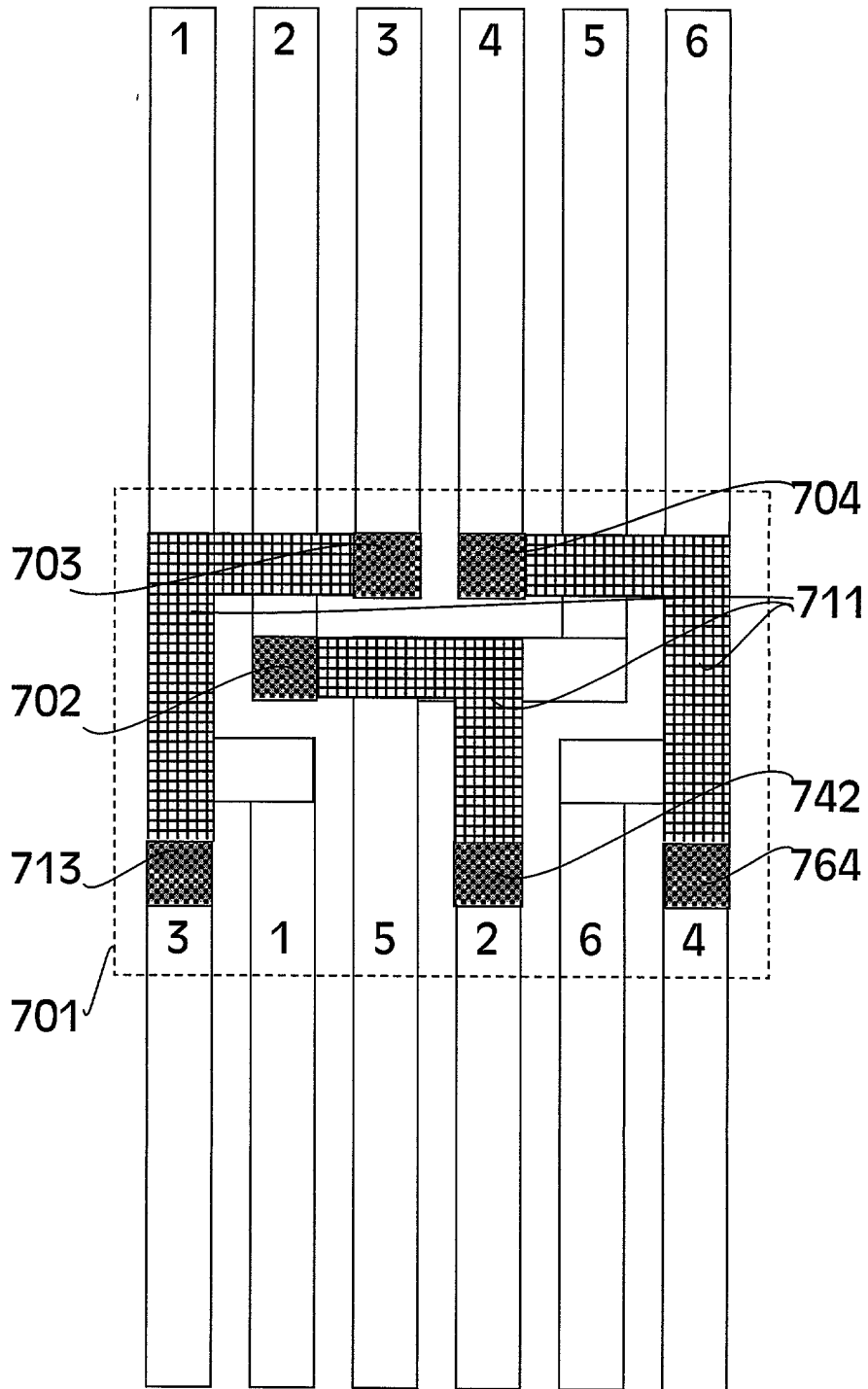
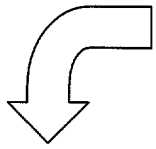

FIG. 7

FIG. 8a

| | | | | | | |
|---|---|---|---|---|---|---|
| | 1 | 2 | 3 | 4 | 5 | 6 |
| 1 | 1 | 1 | 0 | 0 | 0 | 0 |
| 2 | 1 | 1 | 1 | 0 | 0 | 0 |
| 3 | 0 | 1 | 1 | 1 | 0 | 0 |
| 4 | 0 | 0 | 1 | 1 | 1 | 0 |
| 5 | 0 | 0 | 0 | 1 | 1 | 1 |
| 6 | 0 | 0 | 0 | 0 | 1 | 1 |

806



| | | | | | |
|---|---|---|---|---|---|
| 4 | 1 | 5 | 2 | 6 | 3 |
|---|---|---|---|---|---|

804

| | | | | | | |
|---|---|---|---|---|---|---|
| | 1 | 2 | 3 | 4 | 5 | 6 |
| 1 | 1 | 1 | 0 | 1 | 1 | 0 |
| 2 | 1 | 1 | 1 | 0 | 1 | 1 |
| 3 | 0 | 1 | 1 | 1 | 0 | 1 |
| 4 | 1 | 0 | 1 | 1 | 1 | 0 |
| 5 | 1 | 1 | 0 | 1 | 1 | 1 |
| 6 | 0 | 1 | 1 | 0 | 1 | 1 |

807

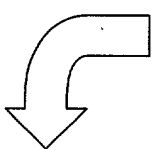

| | | | | | |
|---|---|---|---|---|---|
| 2 | 4 | 6 | 1 | 3 | 5 |
|---|---|---|---|---|---|

814

| | | | | | | |
|---|---|---|---|---|---|---|
| | 1 | 2 | 3 | 4 | 5 | 6 |
| 1 | 1 | 1 | 1 | 1 | 1 | 1 |
| 2 | 1 | 1 | 1 | 1 | 1 | 1 |
| 3 | 1 | 1 | 1 | 1 | 1 | 1 |
| 4 | 1 | 1 | 1 | 1 | 1 | 1 |
| 5 | 1 | 1 | 1 | 1 | 1 | 1 |
| 6 | 1 | 1 | 1 | 1 | 1 | 1 |

808

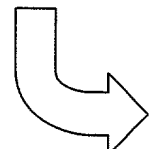
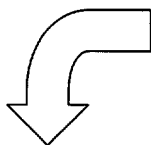

FIG. 8b

| | 1 | 2 | 3 | 4 | 5 | 6 |
|---|---|---|---|---|---|---|
| 1 | x | 0 | x | x | x | x |
| 2 | 0 | x | 0 | x | x | x |
| 3 | x | 0 | x | 0 | x | x |
| 4 | x | x | 0 | x | 0 | x |
| 5 | x | x | x | 0 | x | 0 |
| 6 | x | x | x | x | 0 | x |

816



| | | | | | |
|---|---|---|---|---|---|
| 4 | 1 | 5 | 2 | 6 | 3 |
|---|---|---|---|---|---|

804

| | 1 | 2 | 3 | 4 | 5 | 6 |
|---|---|---|---|---|---|---|
| 1 | x | 0 | x | 1 | 1 | x |
| 2 | 0 | x | 0 | x | 1 | 1 |
| 3 | x | 0 | x | 0 | x | 1 |
| 4 | 1 | x | 0 | x | 0 | x |
| 5 | 1 | 1 | x | 0 | x | 0 |
| 6 | x | 1 | 1 | x | 0 | x |

817

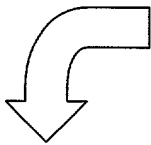

| | | | | | |
|---|---|---|---|---|---|
| 2 | 4 | 6 | 1 | 3 | 5 |
|---|---|---|---|---|---|

814

| | 1 | 2 | 3 | 4 | 5 | 6 |
|---|---|---|---|---|---|---|
| 1 | x | 0 | 2 | 1 | 1 | 2 |
| 2 | 0 | x | 0 | 2 | 1 | 1 |
| 3 | 2 | 0 | x | 0 | 2 | 1 |
| 4 | 1 | 2 | 0 | x | 0 | 2 |
| 5 | 1 | 1 | 2 | 0 | x | 0 |
| 6 | 2 | 1 | 1 | 2 | 0 | x |

818

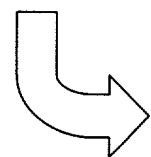

FIG. 8c

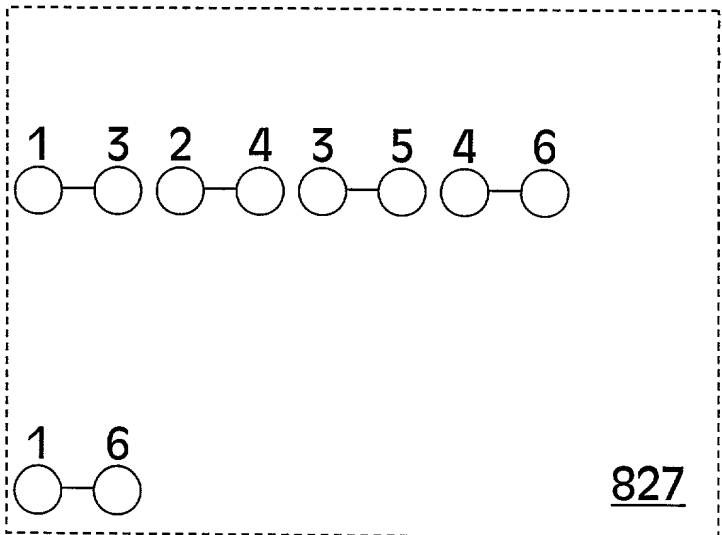
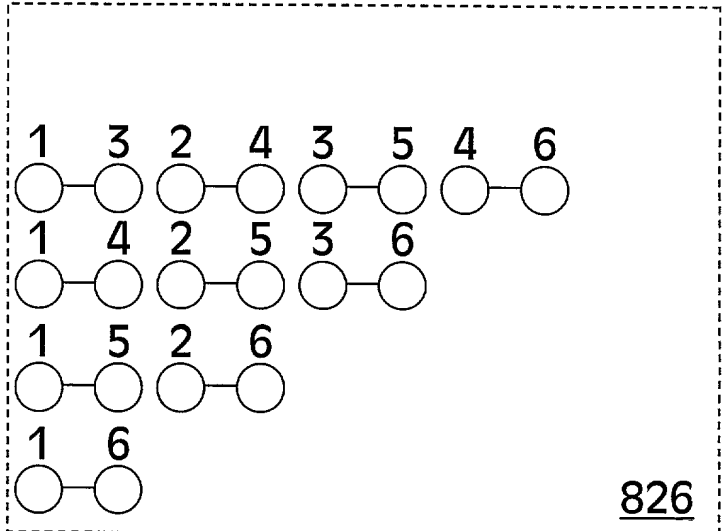
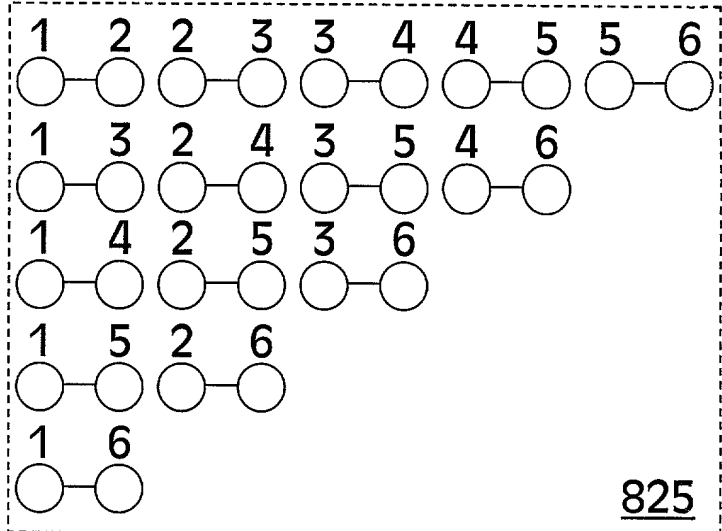
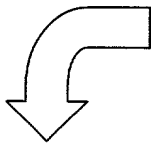
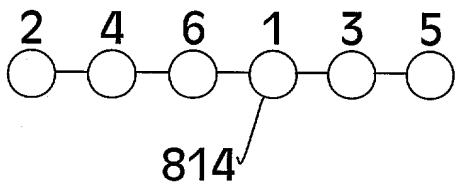
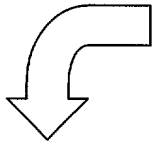
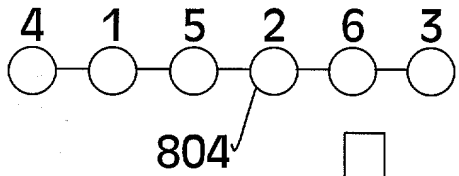
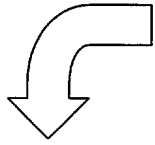
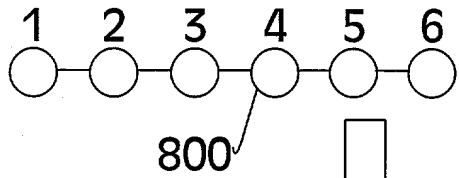

FIG. 9a

FIG. 9a

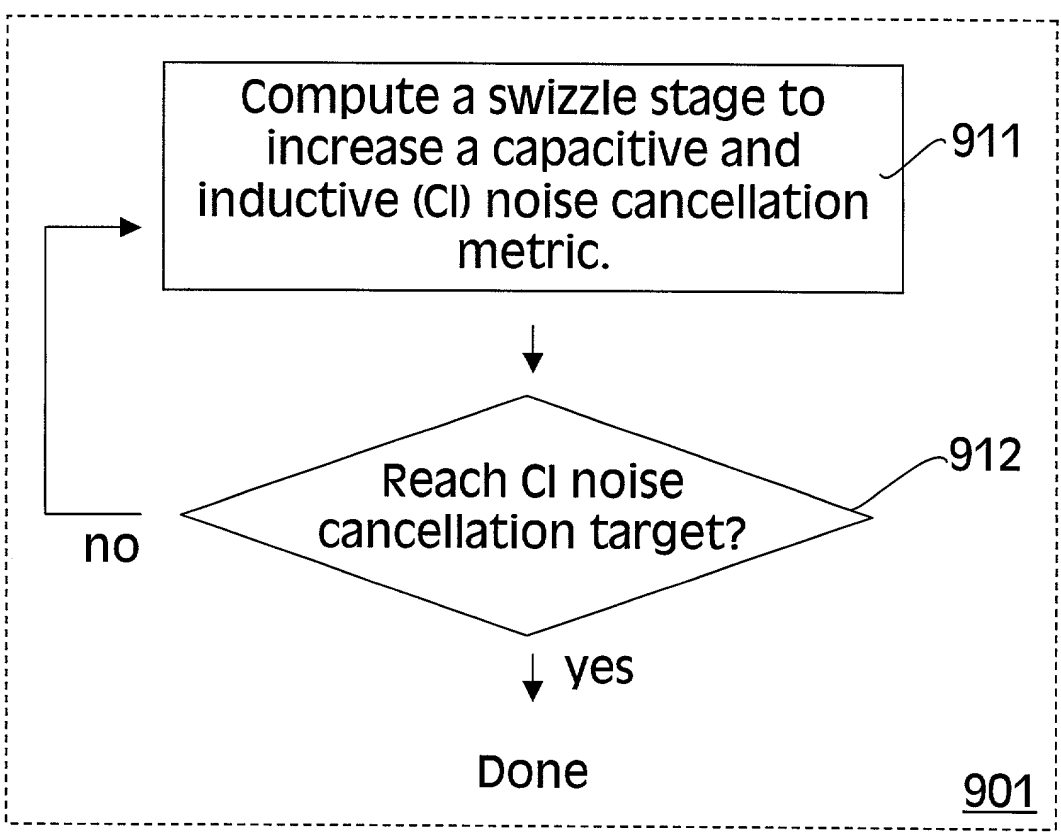
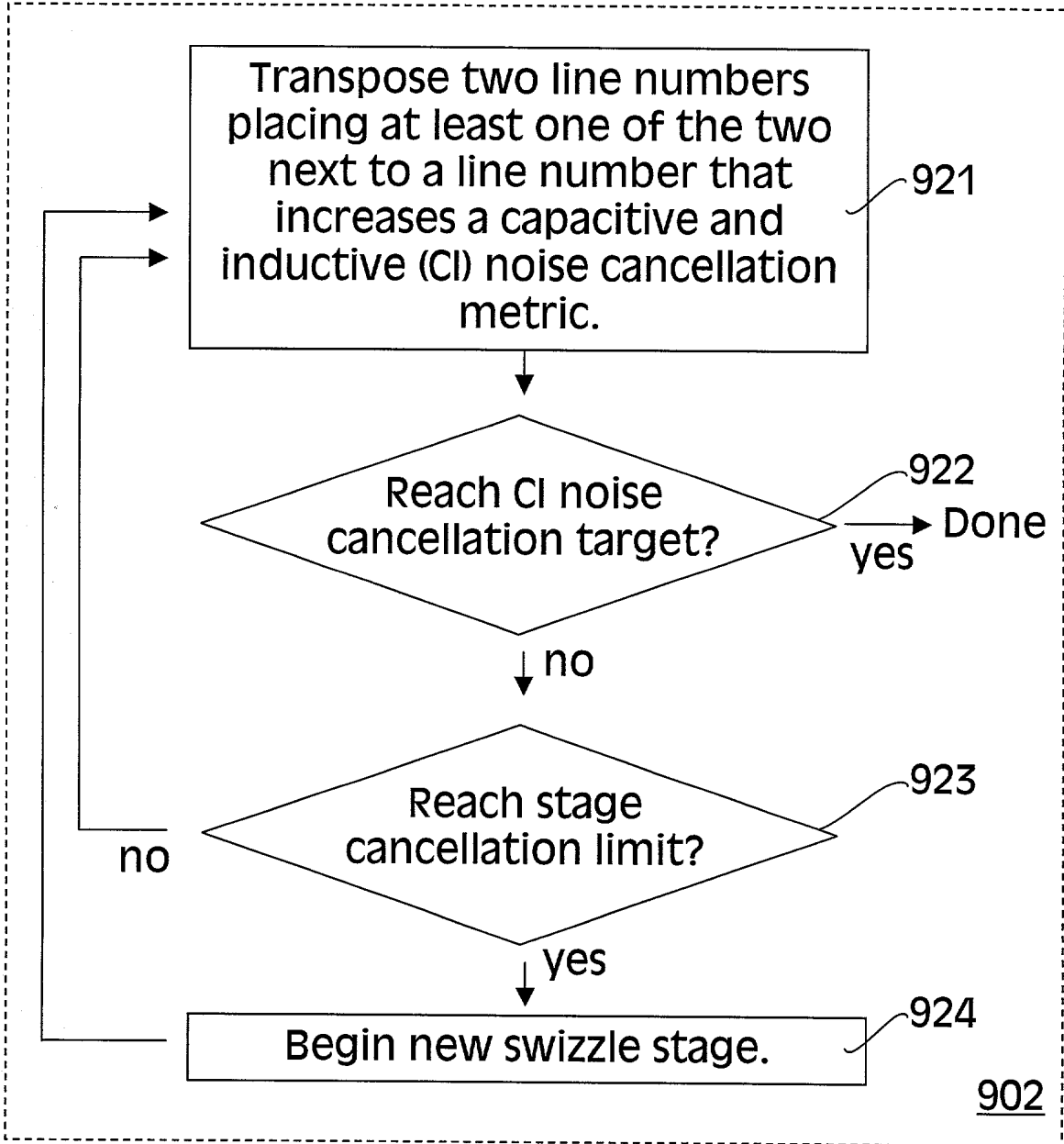

FIG. 9b

FIG. 9b



902

FIG. 9c

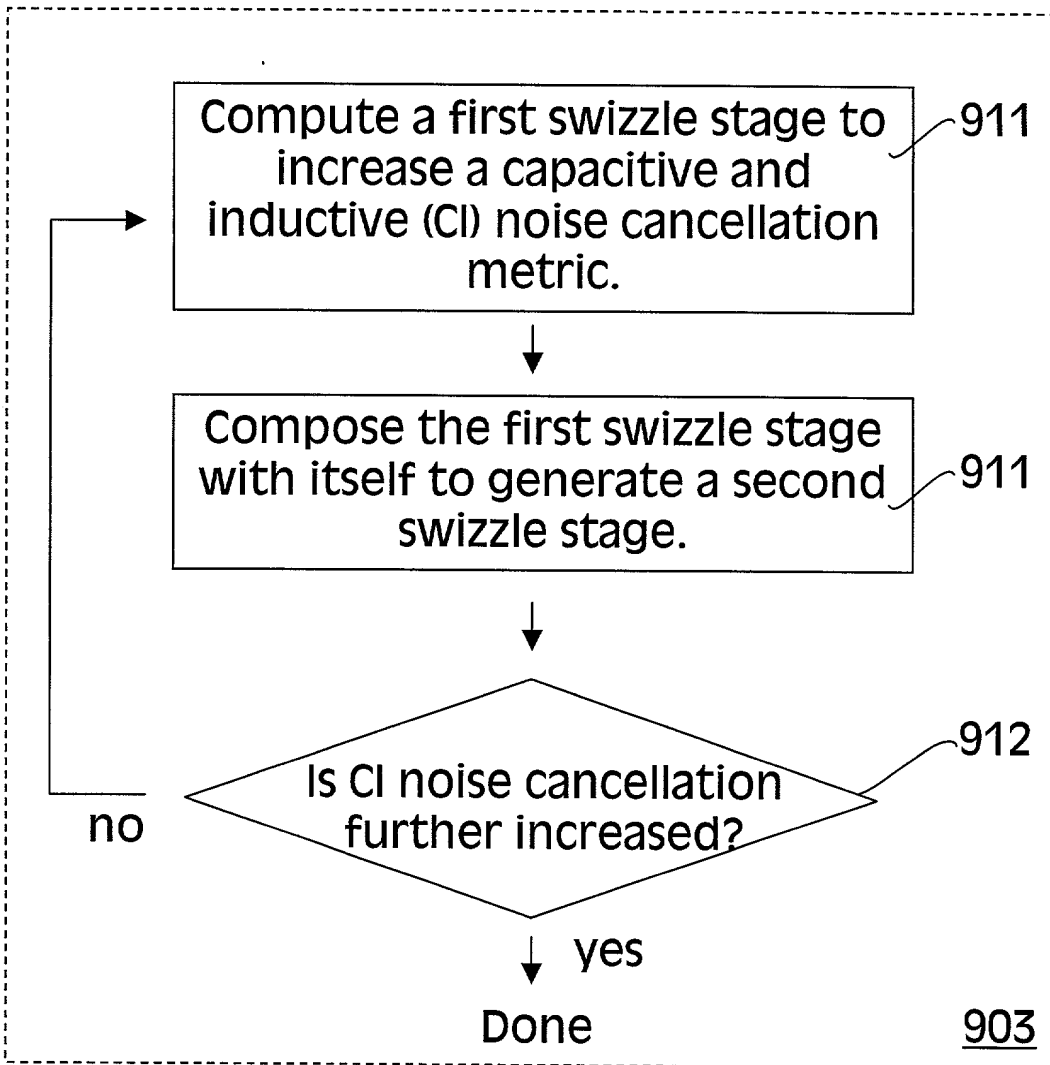

FIG. 9c

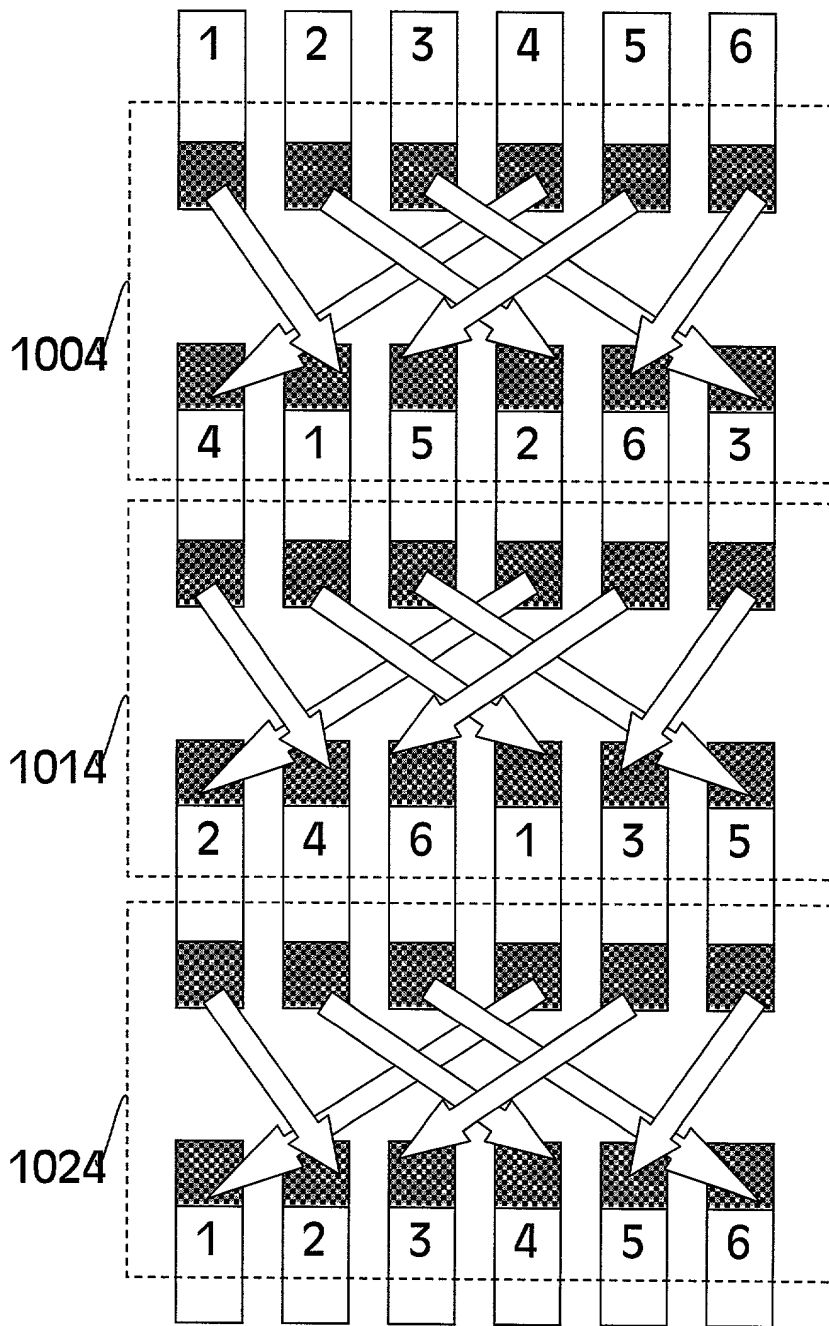

FIG. 10a

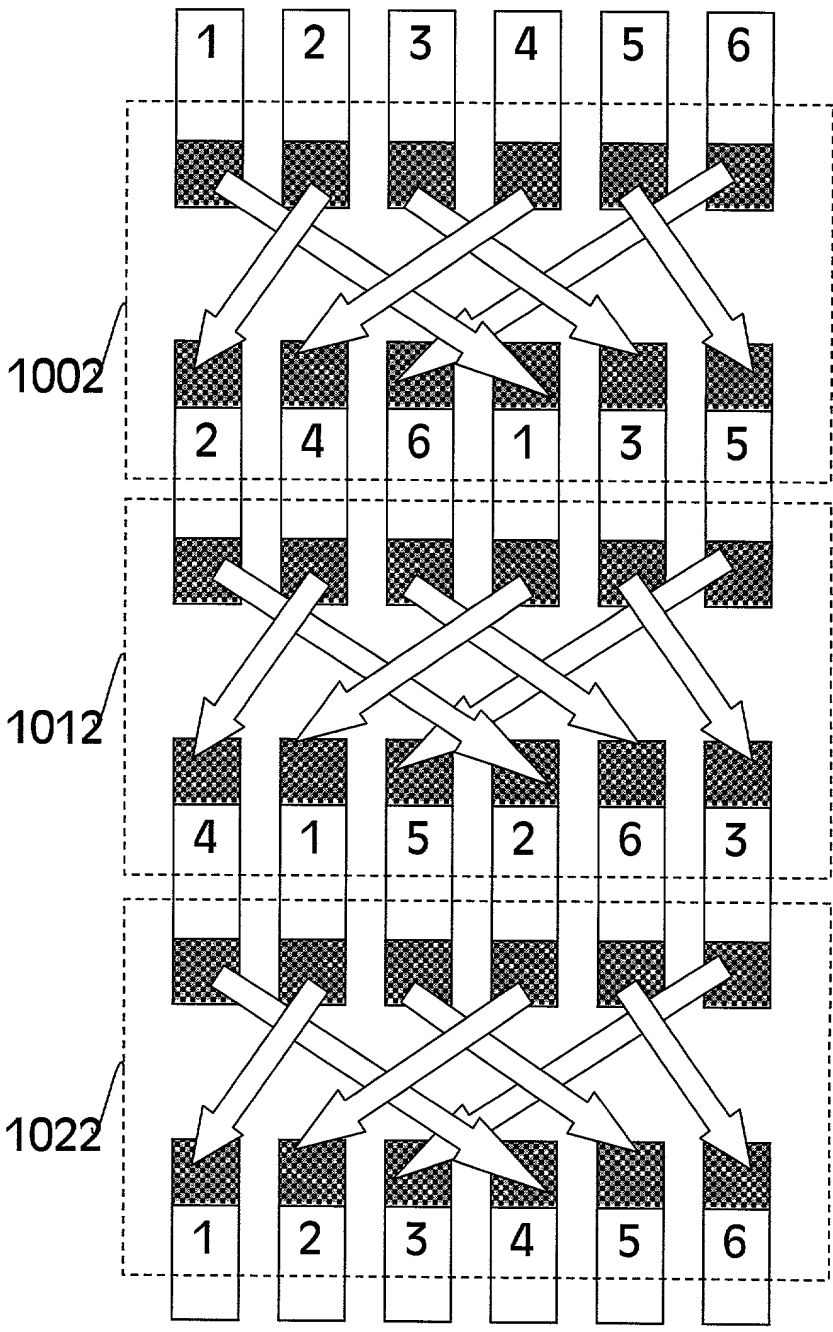

FIG. 10b

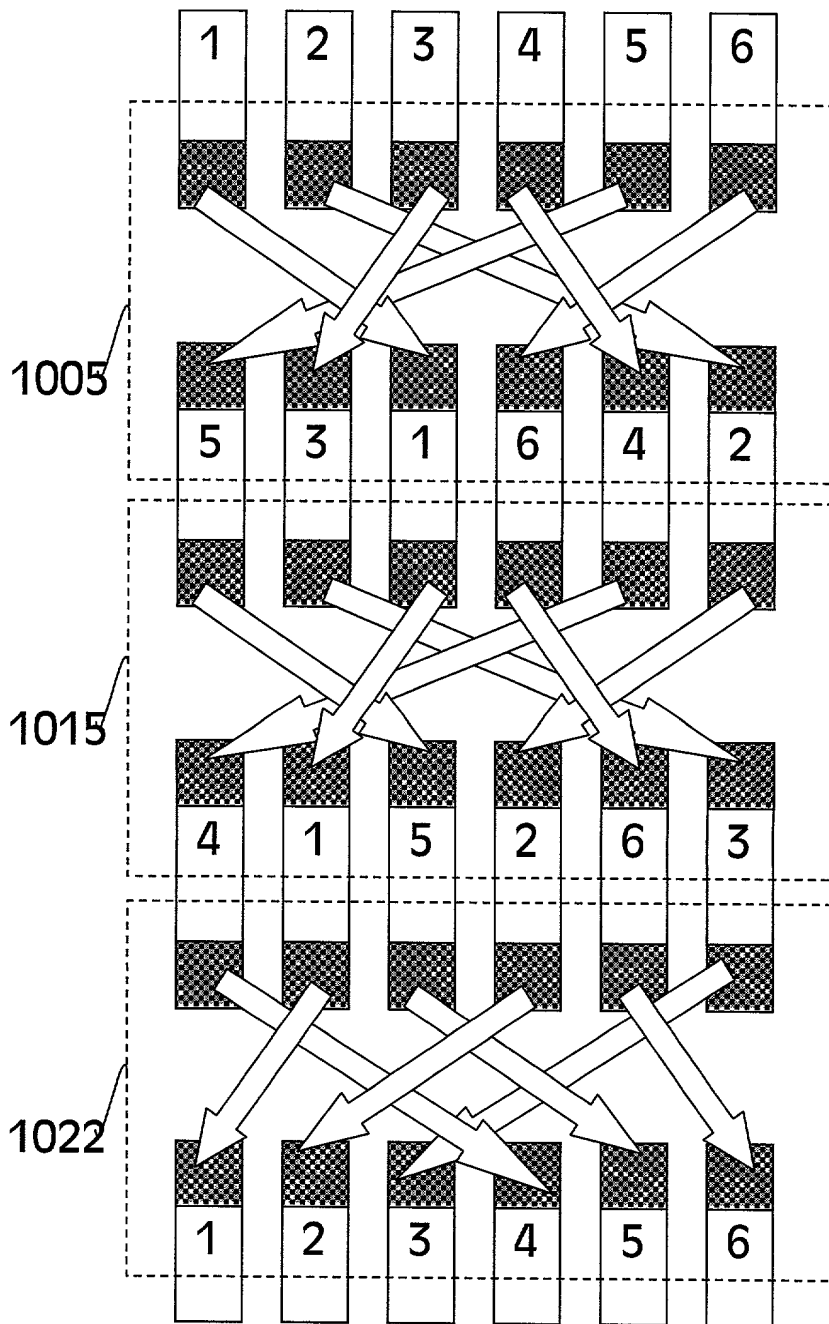

FIG. 10c

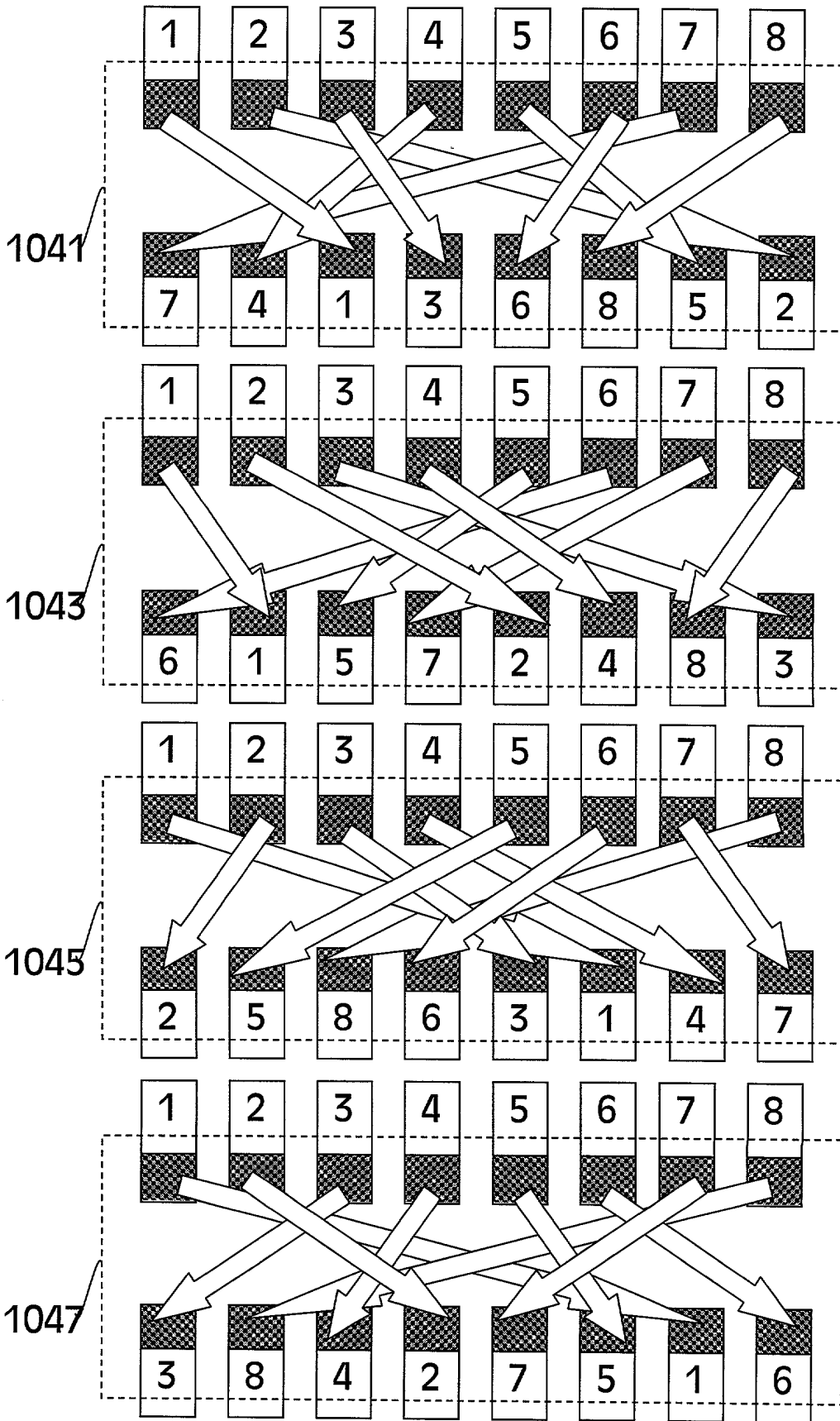

FIG. 10d

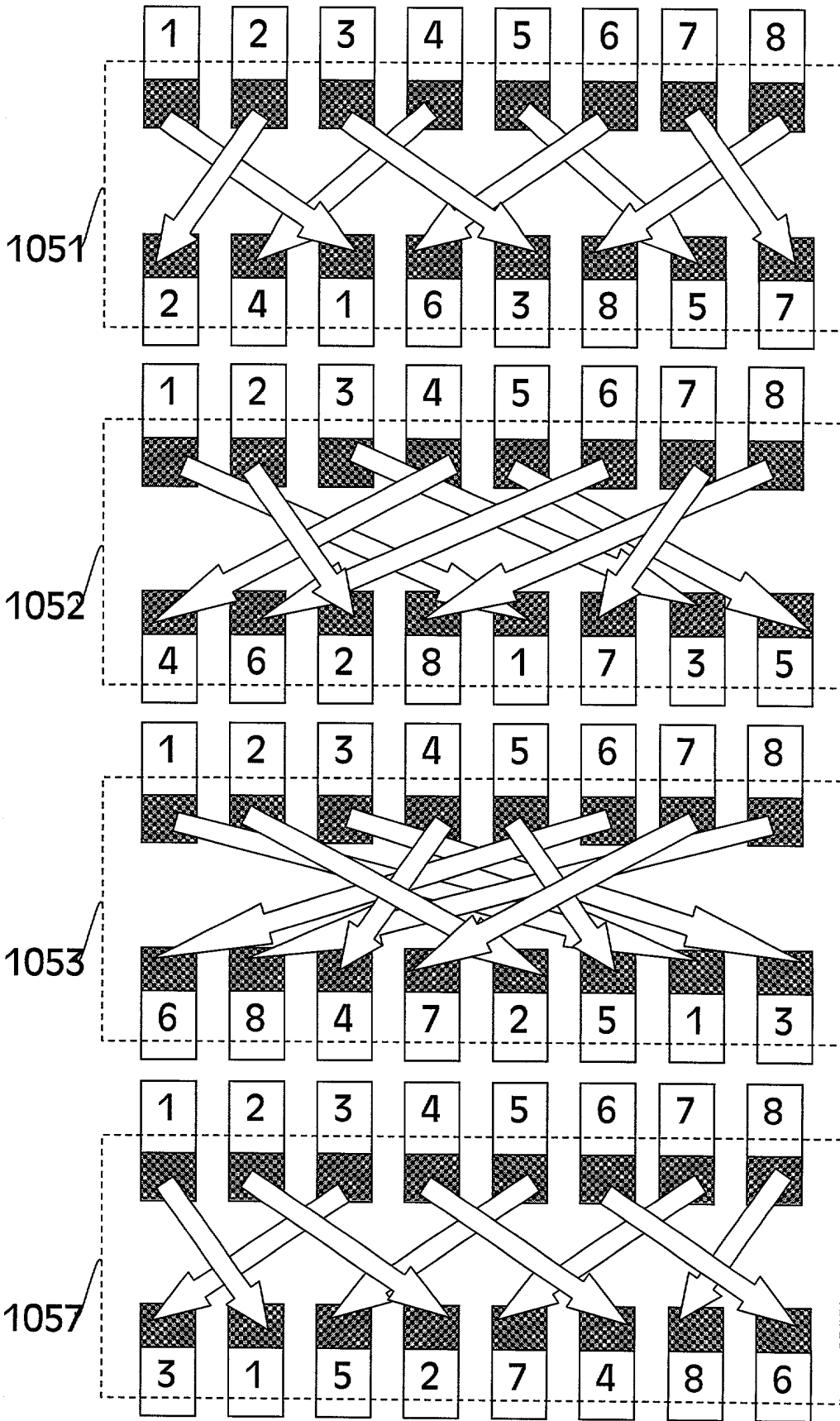

FIG. 10e

FIG. 11a

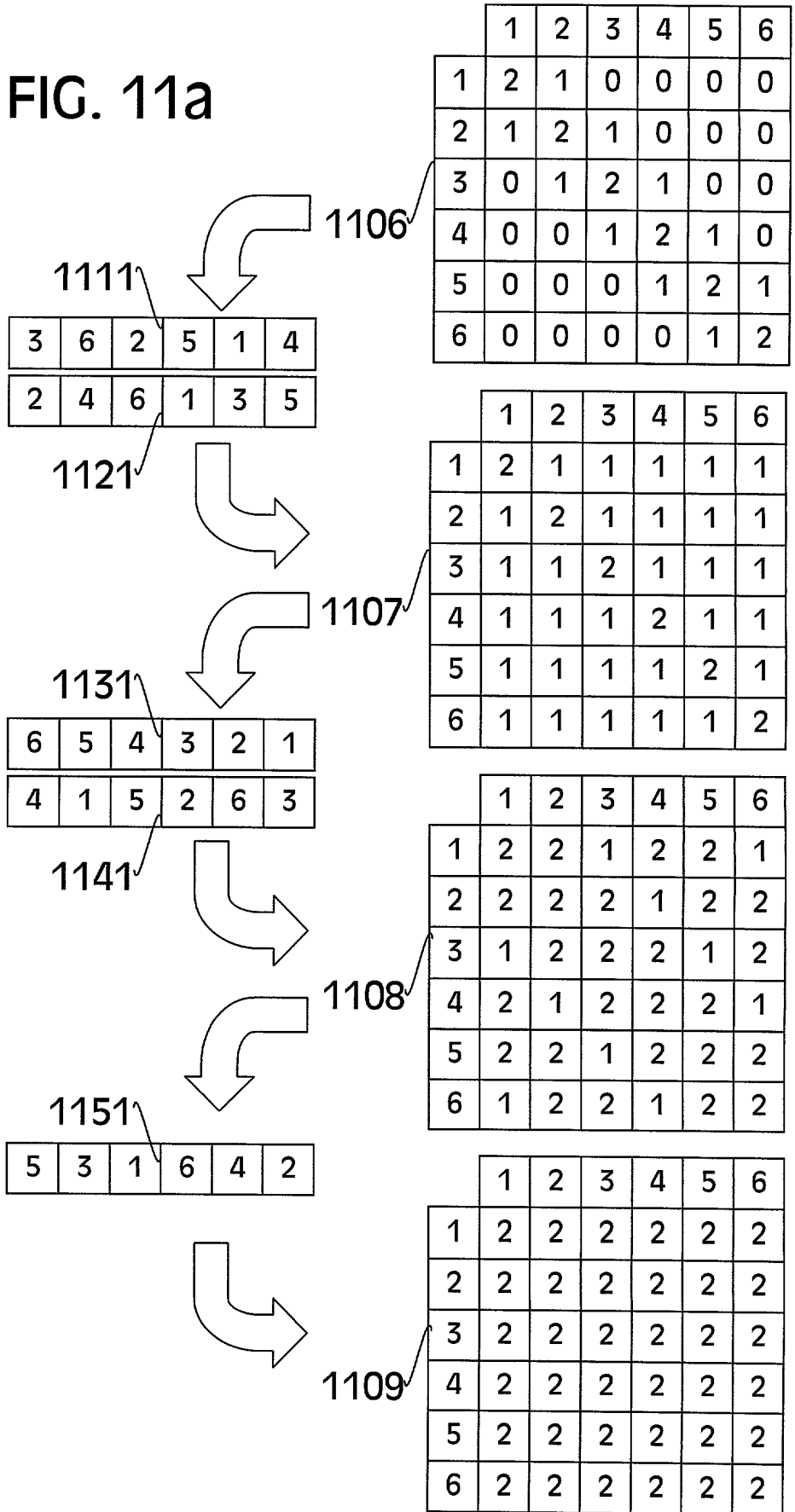

FIG. 11b

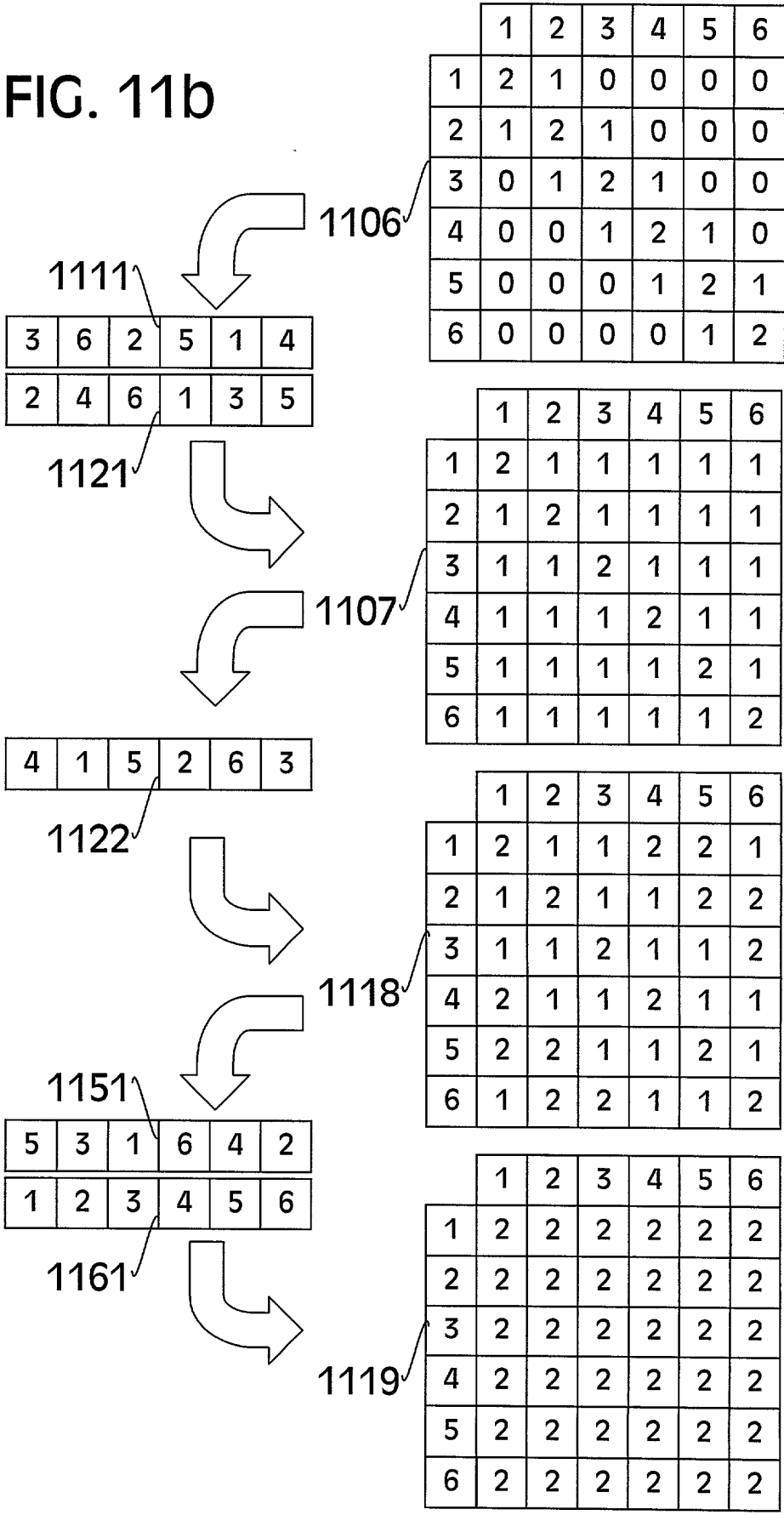
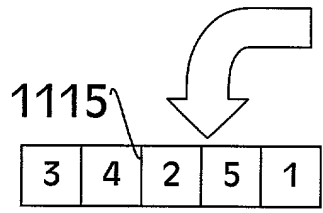
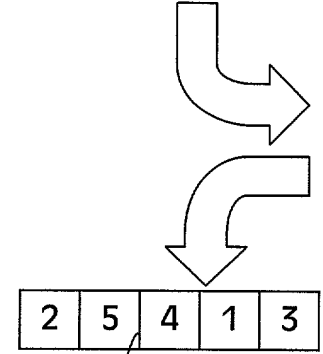

FIG. 11c



| | | | | | |
|---|---|---|---|---|---|
| | 1 | 2 | 3 | 4 | 5 |
| 1 | 2 | 1 | 0 | 0 | 0 |
| 2 | 1 | 2 | 1 | 0 | 0 |
| 3 | 0 | 1 | 2 | 1 | 0 |
| 4 | 0 | 0 | 1 | 2 | 1 |
| 5 | 0 | 0 | 0 | 1 | 2 |



| | | | | | |
|---|---|---|---|---|---|
| | 1 | 2 | 3 | 4 | 5 |
| 1 | 2 | 1 | 0 | 0 | 1 |
| 2 | 1 | 2 | 1 | 1 | 1 |
| 3 | 0 | 1 | 2 | 2 | 0 |
| 4 | 0 | 1 | 2 | 2 | 1 |
| 5 | 1 | 1 | 0 | 1 | 2 |

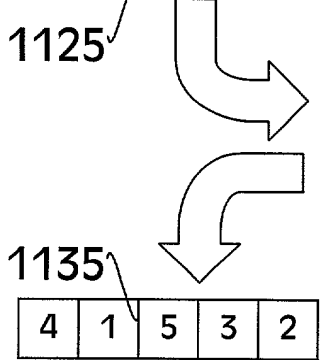

| | | | | | |
|---|---|---|---|---|---|
| | 1 | 2 | 3 | 4 | 5 |
| 1 | 2 | 1 | 1 | 1 | 1 |
| 2 | 1 | 2 | 1 | 1 | 2 |
| 3 | 1 | 1 | 2 | 2 | 0 |
| 4 | 1 | 1 | 2 | 2 | 2 |
| 5 | 1 | 2 | 0 | 2 | 2 |

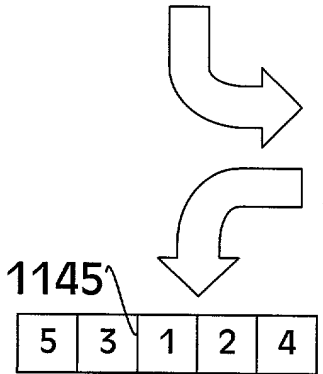

| | | | | | |
|---|---|---|---|---|---|
| | 1 | 2 | 3 | 4 | 5 |
| 1 | 2 | 1 | 1 | 2 | 2 |
| 2 | 1 | 2 | 2 | 1 | 2 |
| 3 | 1 | 2 | 2 | 2 | 1 |
| 4 | 2 | 1 | 2 | 2 | 2 |
| 5 | 2 | 2 | 1 | 2 | 2 |

| | | | | | |
|---|---|---|---|---|---|
| | 1 | 2 | 3 | 4 | 5 |
| 1 | 2 | 2 | 2 | 2 | 2 |
| 2 | 2 | 2 | 2 | 2 | 2 |
| 3 | 2 | 2 | 2 | 2 | 2 |
| 4 | 2 | 2 | 2 | 2 | 2 |
| 5 | 2 | 2 | 2 | 2 | 2 |

1126

1127

1128

1129

1130

FIG. 12a

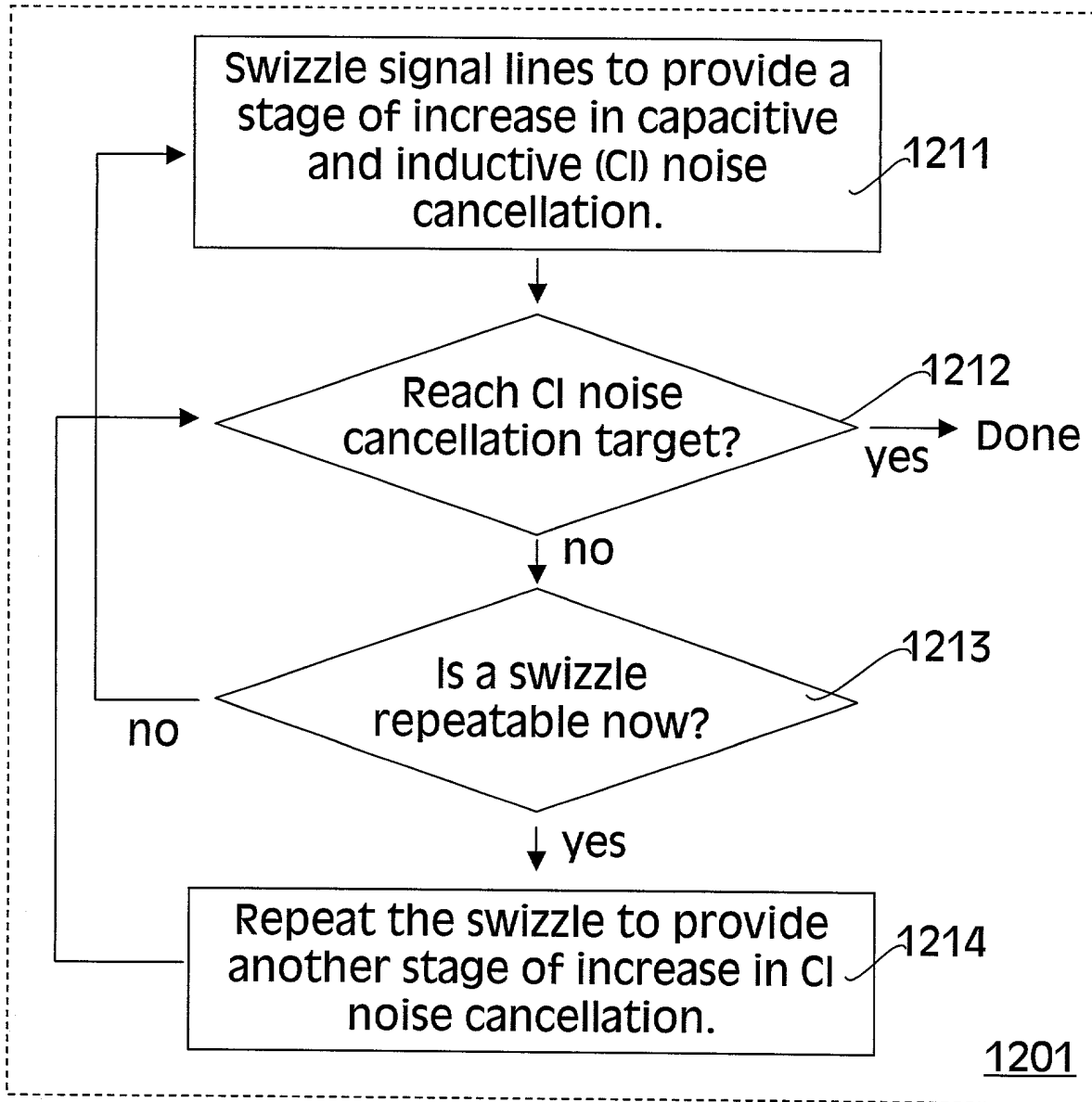
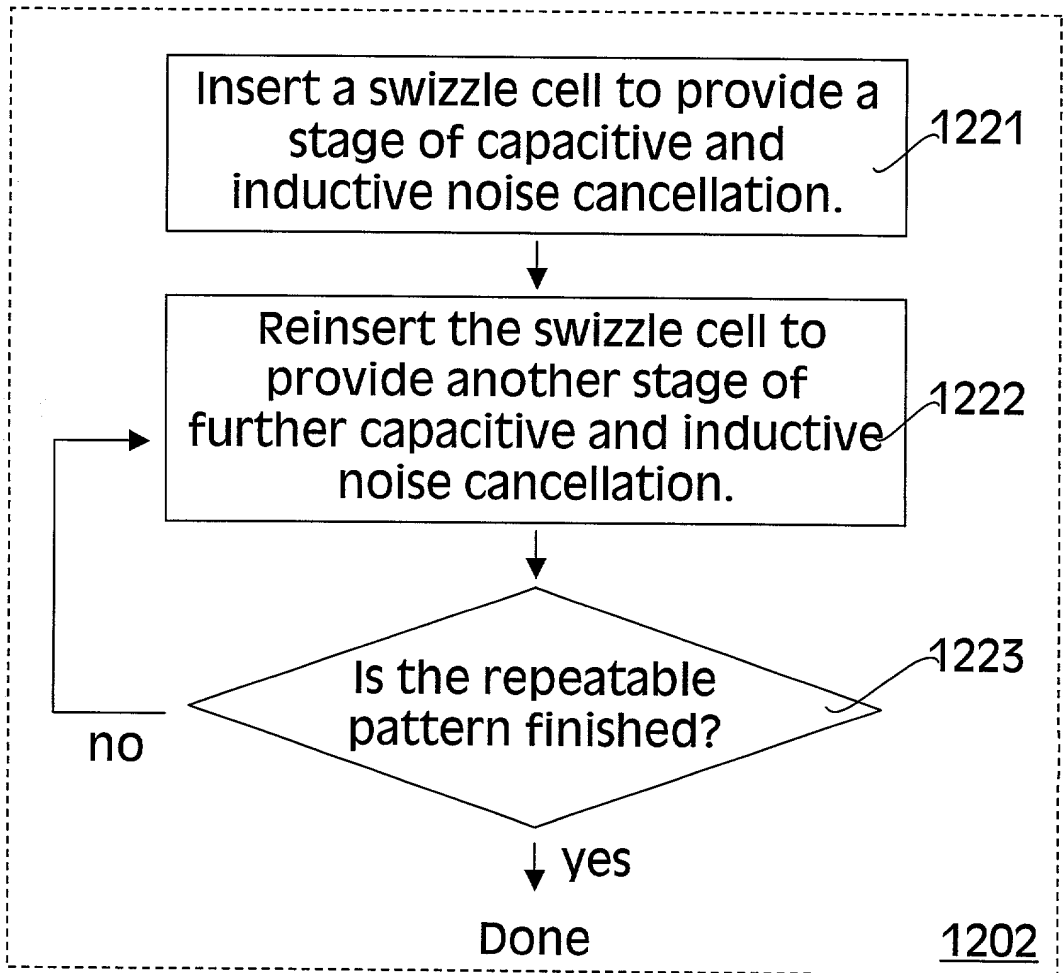

FIG. 12b



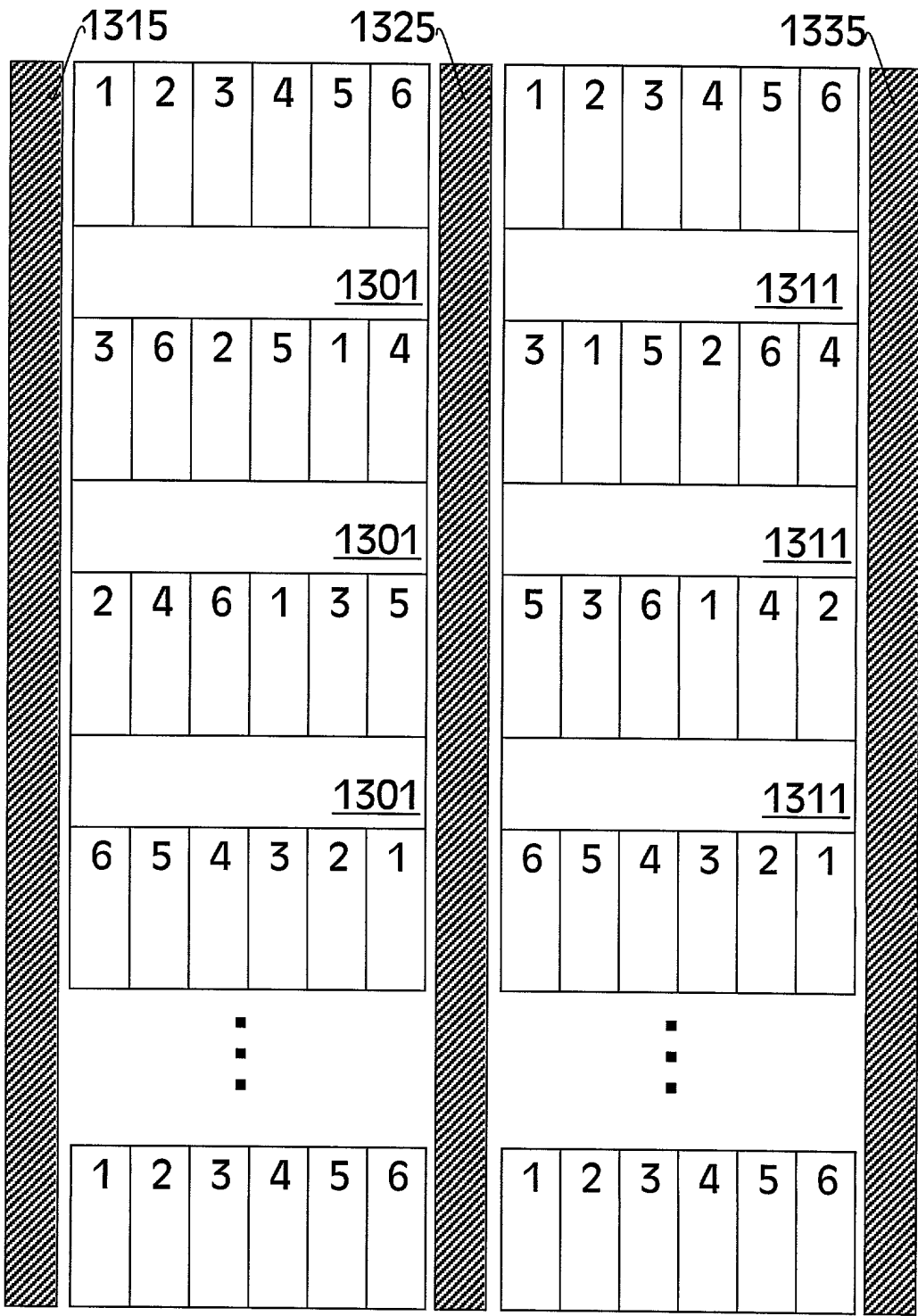

FIG. 13a

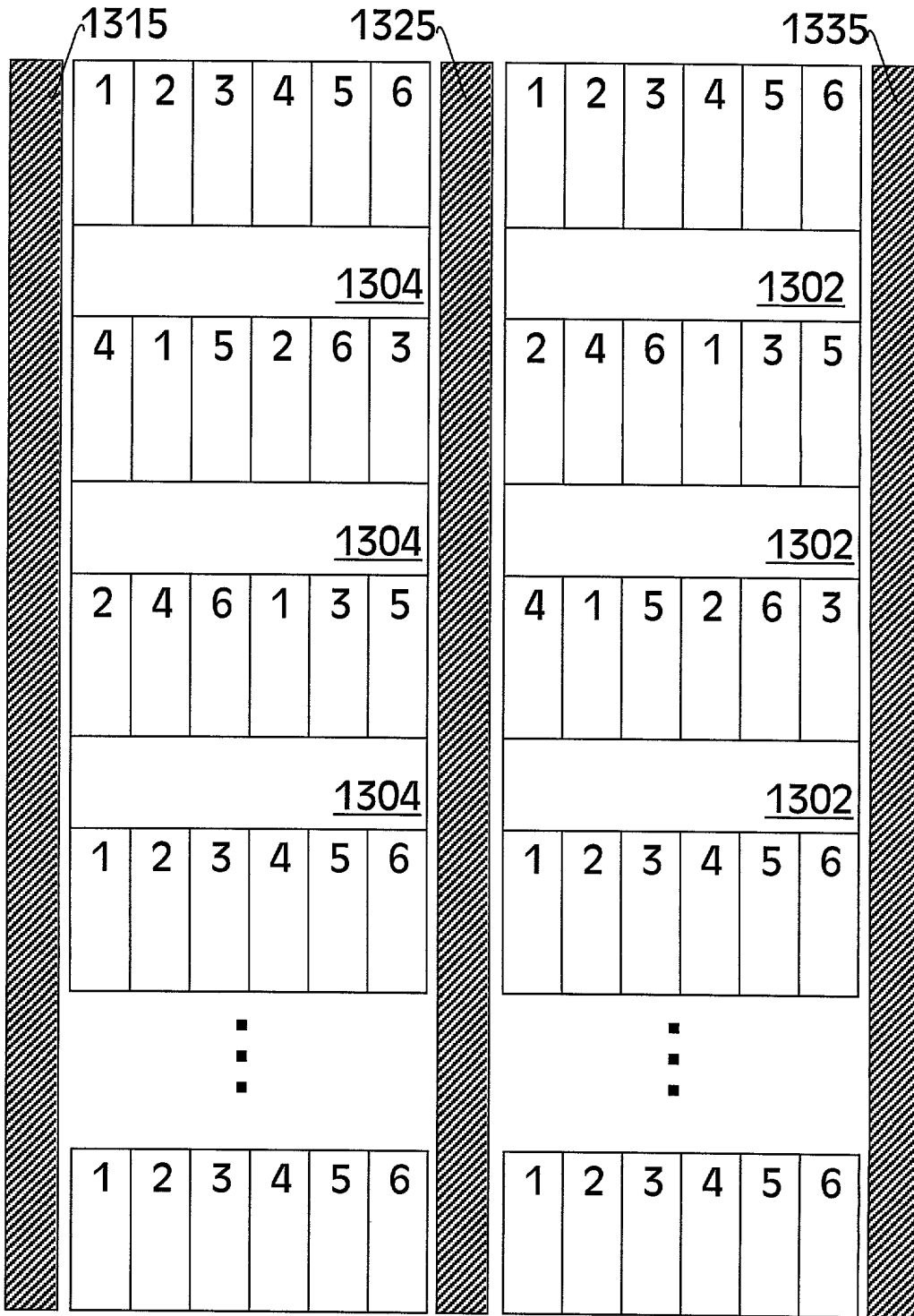

FIG. 13b

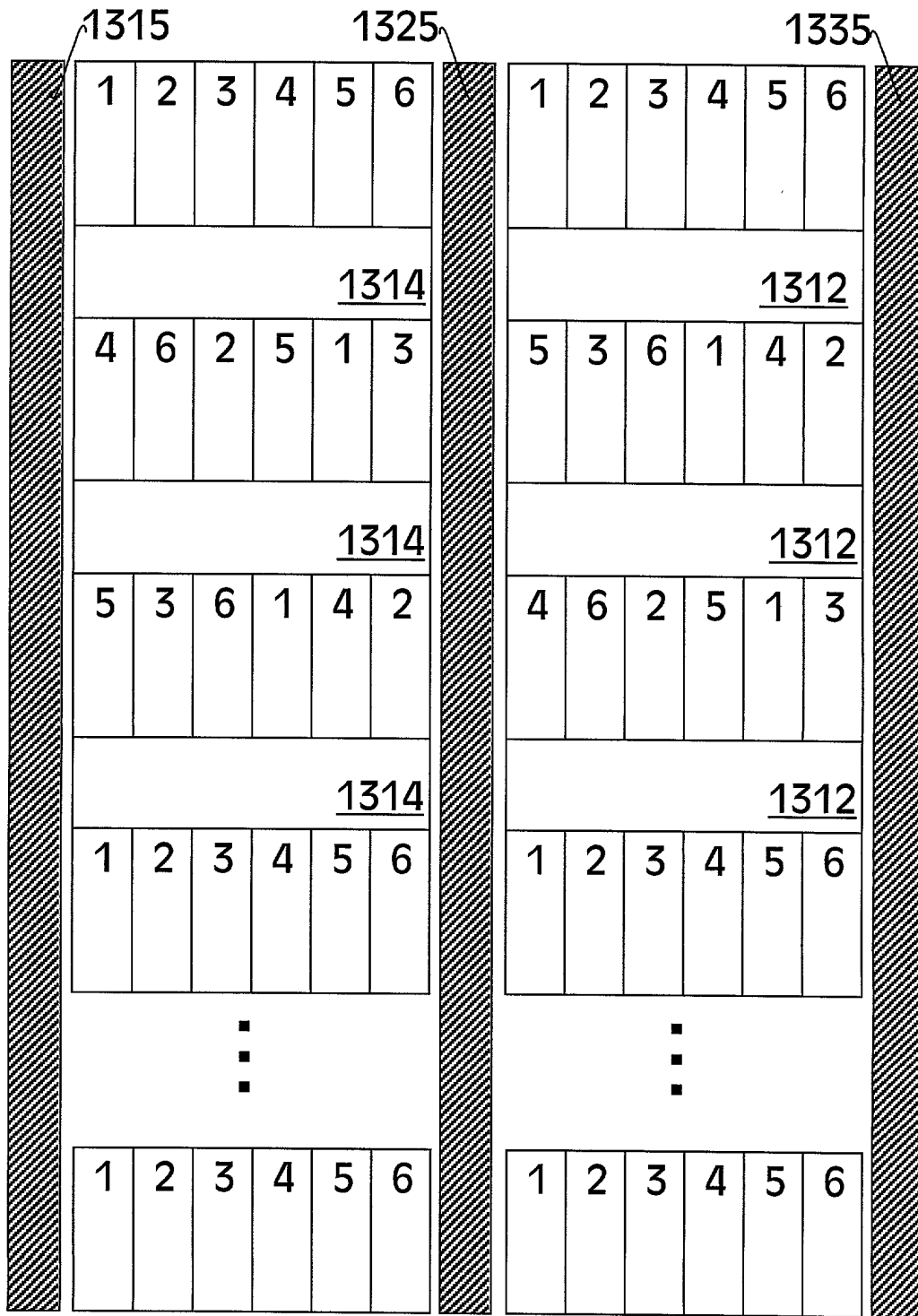

FIG. 13c

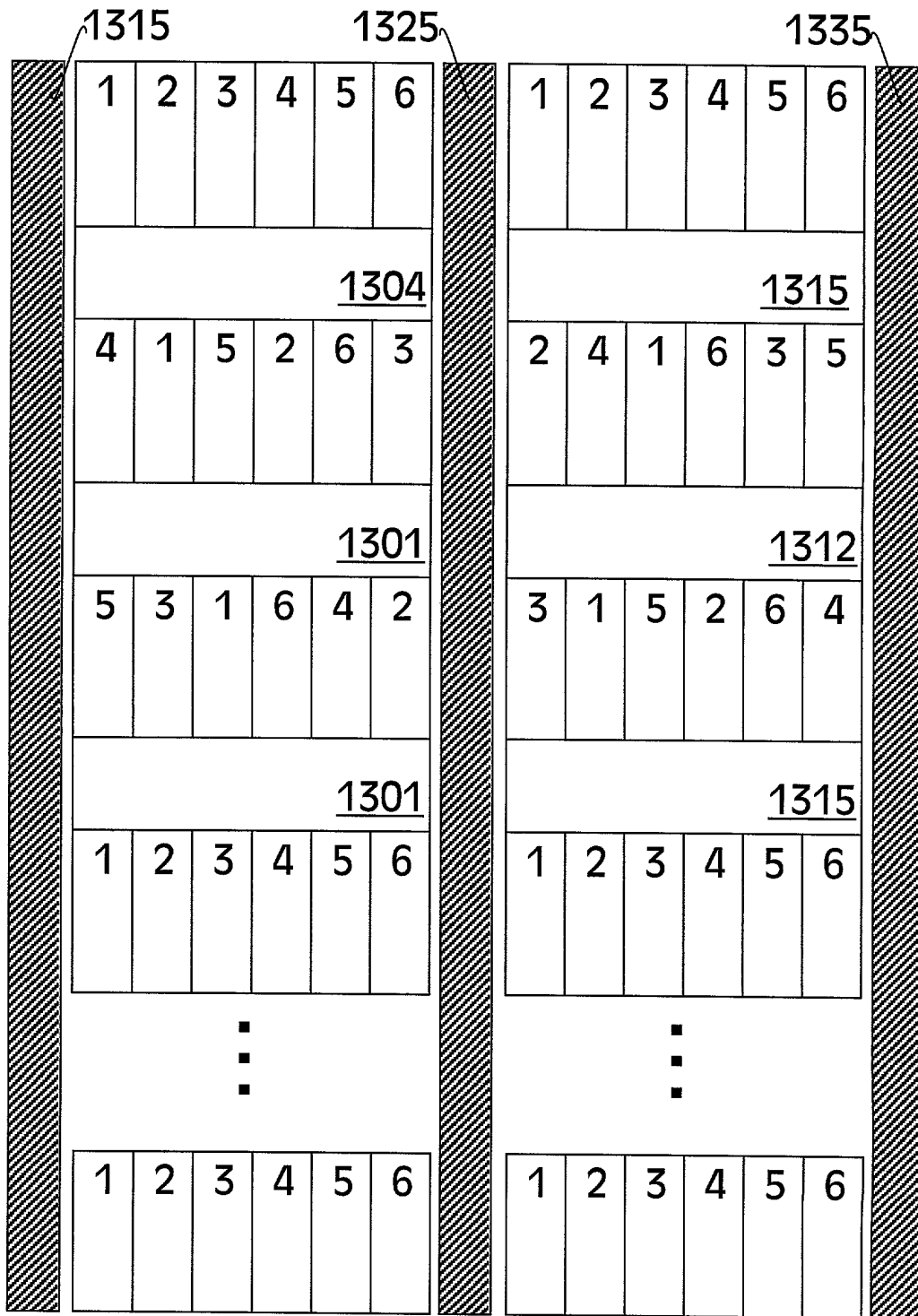

FIG. 13d

FIG. 14

FIG. 14

